

# GW KAMJBA.CM

## SOLERIQ® S 12

The SOLERIQ® S products were specifically designed for applications requiring large flux packages out of a compact area.



### Applications

- Downlights/Spotlights

### Features:

- Package: Chip-on-Board
- Typ. Radiation: 120° (Lambertian emitter)
- Color temperature: 3000K - 5000K
- CRI: 90 (min.)
- ESD: 2 kV acc. to ANSI/ESDA/JEDEC JS-001 (HBM, Class 2)
- Luminous Flux: typ. 3073 lm @ 3000 K, 25 °C
- Luminous efficacy: typ. 120 lm/W @ 3000 K, 25 °C

## Ordering Information

Type	Color temperature	Luminous Flux <sup>1)</sup> $I_F = 700 \text{ mA}$ $\Phi_V$	Ordering Code
GW KAMJBA.CM-SUTT-30S3-XX	3000 K	2590 ... 4190 lm	Q65113A0951
GW KAMJBA.CM-SUTT-35S3-XX	3500 K	2590 ... 4190 lm	Q65113A0949
GW KAMJBA.CM-SUTT-40S3-XX	4000 K	2590 ... 4190 lm	Q65113A0950
GW KAMJBA.CM-SUTT-50S3-XX	5000 K	2590 ... 4190 lm	Q65113A0948

## Maximum Ratings

Parameter	Symbol		Values
Operating Temperature	$T_{op}$	min.	-40 °C
		max.	105 °C
Storage Temperature	$T_{stg}$	min.	-40 °C
		max.	105 °C
Junction Temperature	$T_j$	max.	125 °C
Forward Current $T_j = 25\text{ °C}$	$I_F$	max.	1150 mA
Reverse voltage <sup>2)</sup>	$V_R$		Not designed for reverse operation
ESD withstand voltage acc. to ANSI/ESDA/JEDEC JS-001 (HBM, Class 2)	$V_{ESD}$		2 kV

## Characteristics

$I_F = 700 \text{ mA}$ ;  $T_J = 25 \text{ °C}$

Parameter	Symbol		Values
Viewing angle at 50% $I_V$	$2\phi$	typ.	120 °
Forward Voltage <sup>3)</sup>	$V_F$	typ.	36.50 V
Reverse current <sup>2)</sup>	$I_R$		Not designed for reverse operation
Color Rendering Index <sup>4)</sup>	CRI	min.	90
Electrical thermal resistance junction/solderpoint with efficiency $\eta_e = 41 \%$	$R_{thJS \text{ elec.}}$	typ.	0.60 K / W

## Brightness Groups

Group	Luminous Flux <sup>1)</sup> $I_F = 700 \text{ mA}$ min. $\Phi_V$	Luminous Flux <sup>1)</sup> $I_F = 700 \text{ mA}$ max. $\Phi_V$
SU	2590 lm	2800 lm
TP	2800 lm	3040 lm
TQ	3040 lm	3300 lm
TR	3300 lm	3590 lm
TS	3590 lm	3900 lm
TT	3900 lm	4190 lm

### Chromaticity Coordinate Groups <sup>5)</sup>

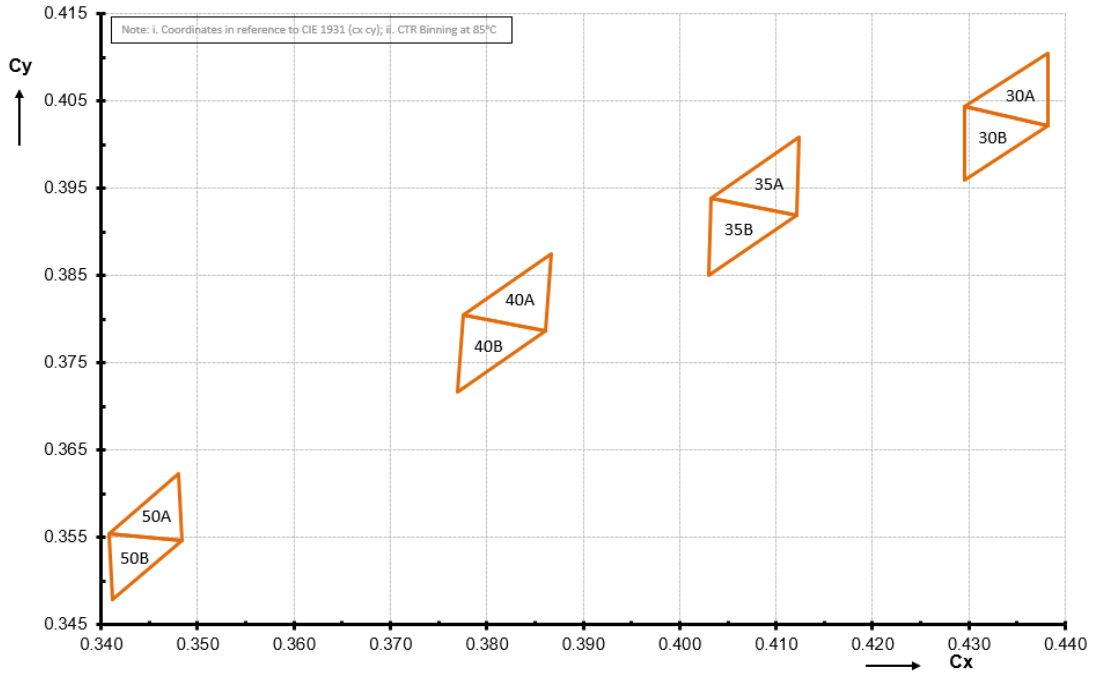

### Chromaticity Coordinate Groups <sup>5)</sup>

Group	Cx	Cy	CCT	Group	Cx	Cy	CCT	Group	Cx	Cy	CCT
30A	0.4296	0.4043	3000	35B	0.4030	0.3850	3500	50A	0.3408	0.3555	5000
	0.4382	0.4105	3000		0.4033	0.3939	3500		0.3480	0.3623	5000
	0.4382	0.4021	3000		0.4121	0.3919	3500		0.3484	0.3547	5000
30B	0.4296	0.3959	3000	40A	0.3775	0.3805	4000	50B	0.3408	0.3555	5000
	0.4296	0.4043	3000		0.3867	0.3875	4000		0.3484	0.3547	5000
	0.4382	0.4021	3000		0.3861	0.3787	4000		0.3412	0.3479	5000
35A	0.4033	0.3939	3500	40B	0.3769	0.3717	4000				
	0.4124	0.4008	3500		0.3775	0.3805	4000				
	0.4121	0.3919	3500		0.3861	0.3787	4000				

---

## Group Name on Label

**Example: SU-30A**

Brightness

Color Chromaticity

---

SU

30A

---

### Relative Spectral Emission <sup>6)</sup>

$\Phi_{rel} = f(\lambda); I_F = 700 \text{ mA}; T_J = 25 \text{ }^\circ\text{C}$

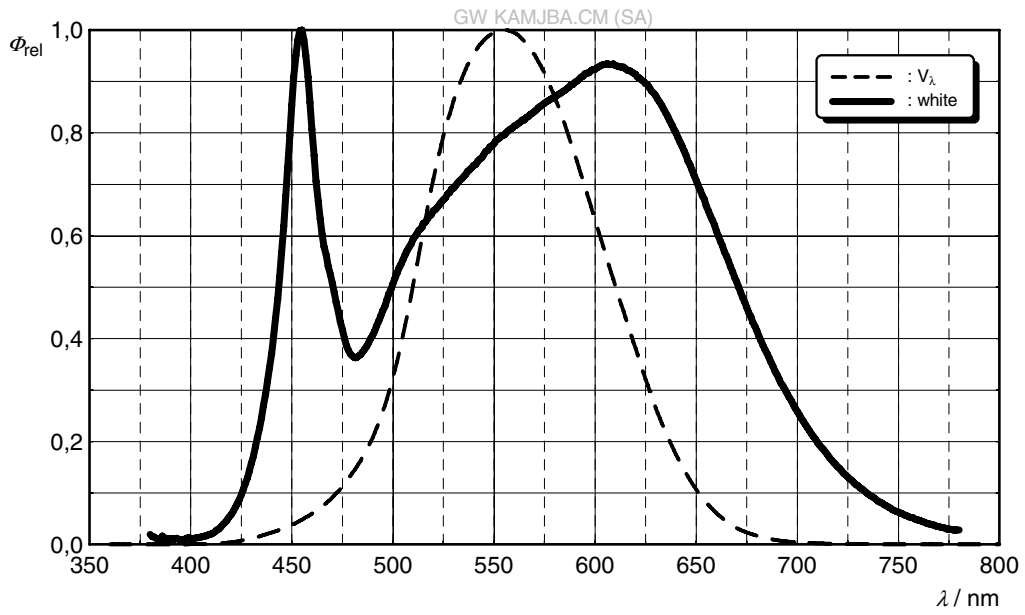

### Radiation Characteristics <sup>6)</sup>

$I_{rel} = f(\phi); T_J = 25 \text{ }^\circ\text{C}$

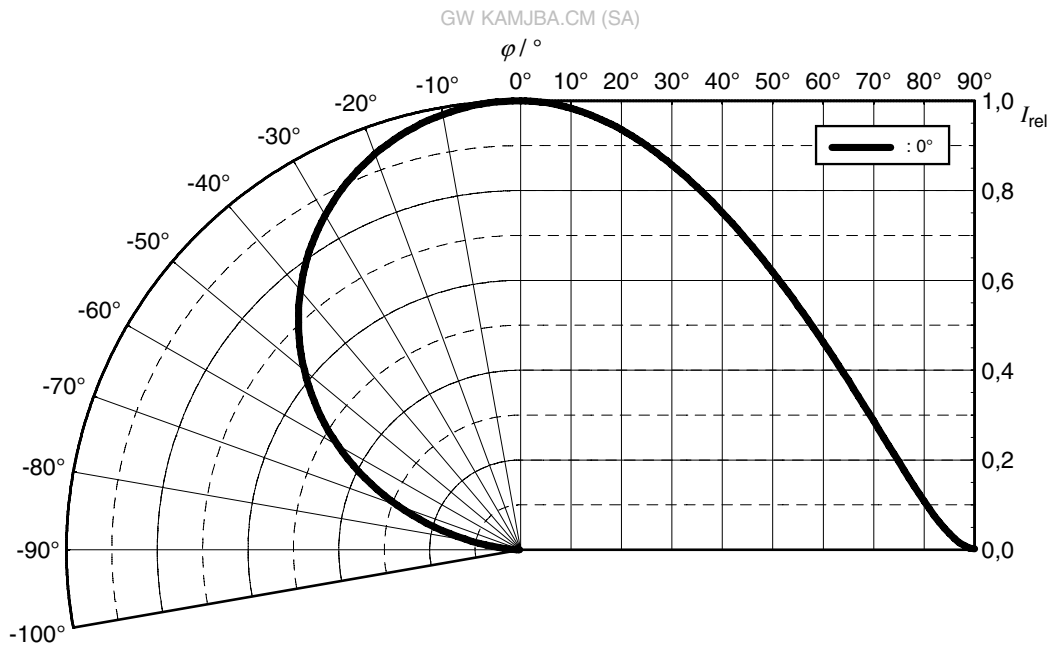

Special Agreement



**Forward current** <sup>6)</sup>

$I_F = f(V_F); T_J = 25\text{ °C}$

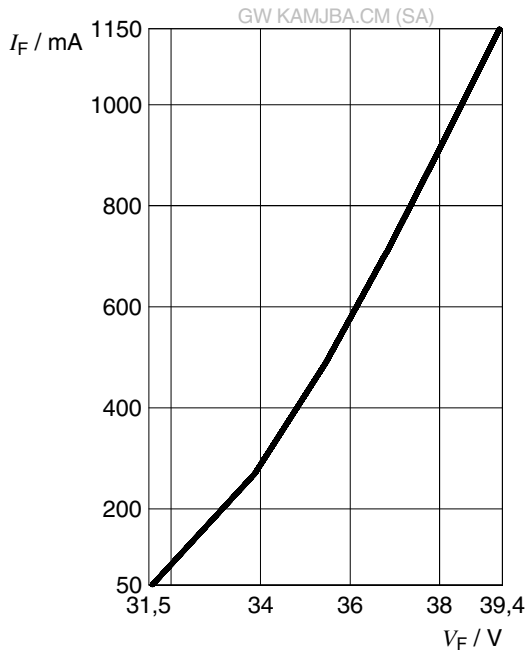

**Relative Luminous Flux** <sup>6), 7)</sup>

$\Phi_V / \Phi_V(700\text{ mA}) = f(I_F); T_J = 25\text{ °C}$

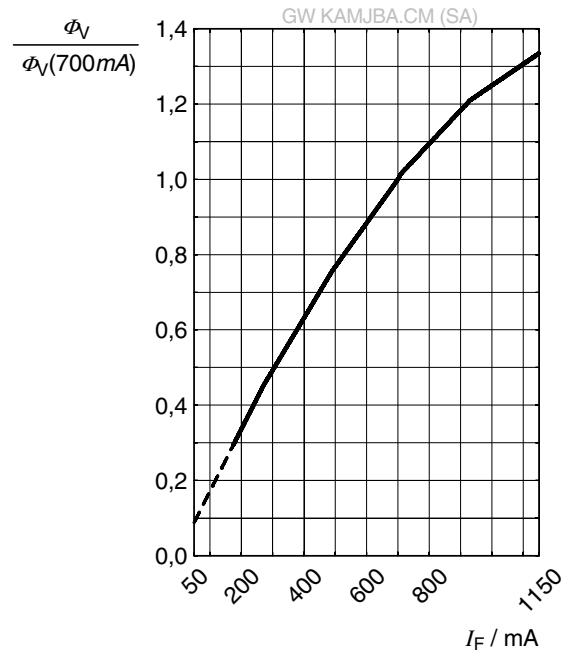

**Chromaticity Coordinate Shift** <sup>6)</sup>

$\Delta Cx, \Delta Cy = f(I_F); T_J = 25\text{ °C}$

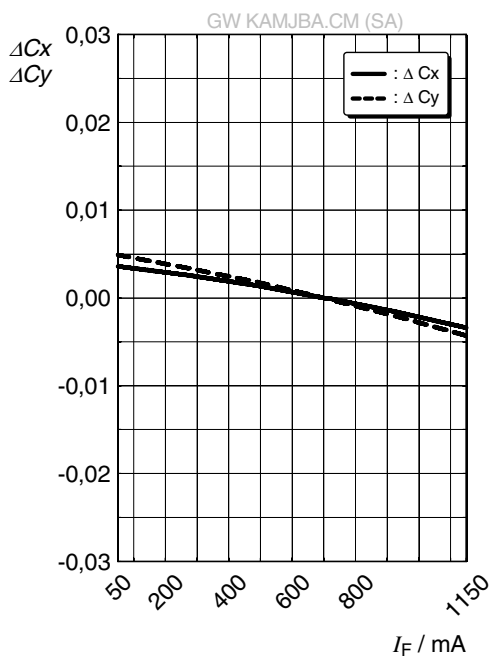

**Forward Voltage** <sup>6)</sup>

$\Delta V_F = V_F - V_F(25\text{ }^\circ\text{C}) = f(T_j); I_F = 700\text{ mA}$

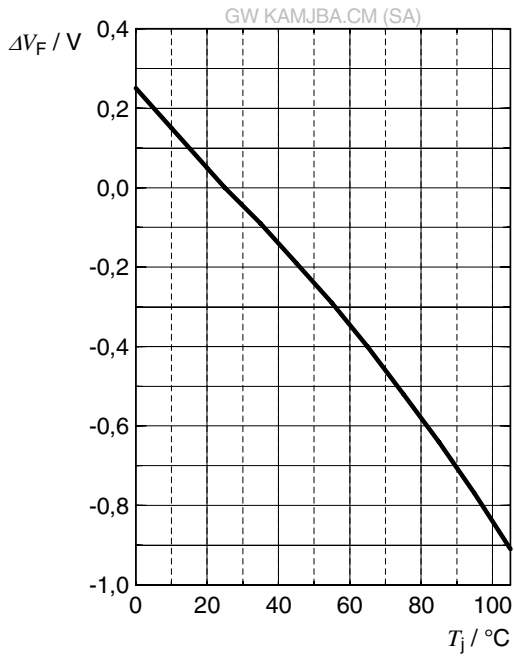

**Relative Luminous Flux** <sup>6)</sup>

$\Phi_v / \Phi_v(25\text{ }^\circ\text{C}) = f(T_j); I_F = 700\text{ mA}$

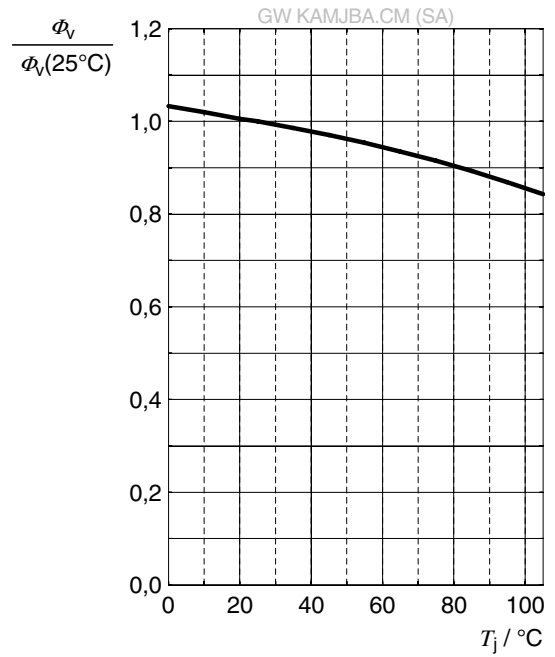

**Chromaticity Coordinate Shift** <sup>6)</sup>

$\Delta C_x, \Delta C_y = f(T_j); I_F = 700\text{ mA}$

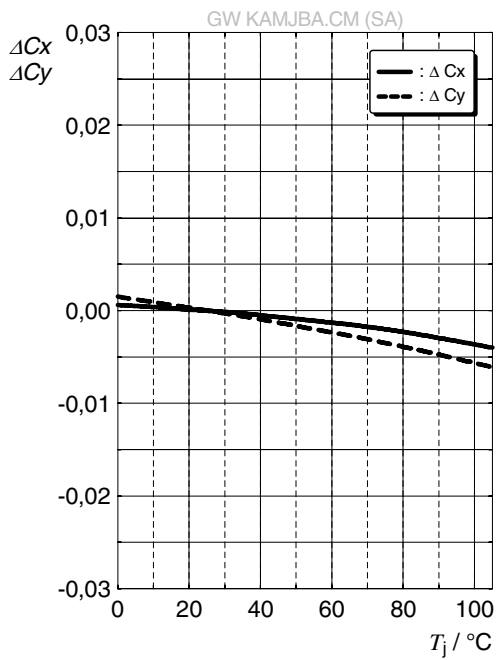

## Max. Permissible Forward Current

$$I_F = f(T)$$

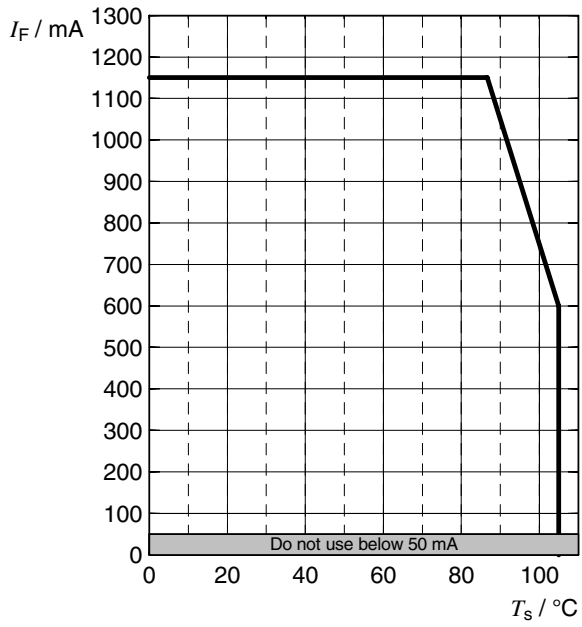

**Dimensional Drawing** <sup>8)</sup>

Marking on backside of COB device

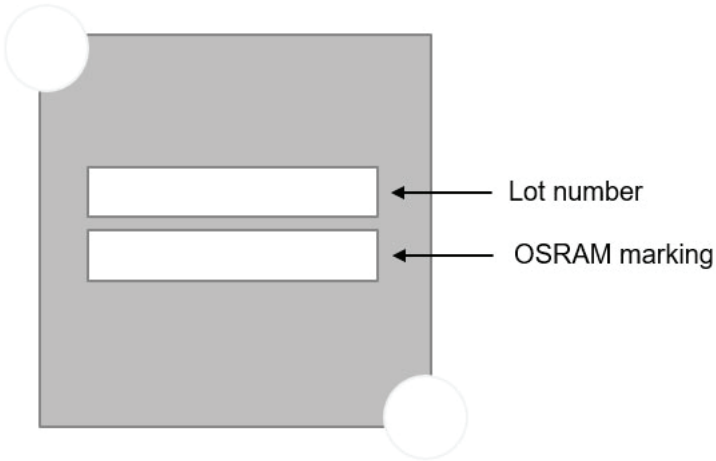

Marking Nomenclature

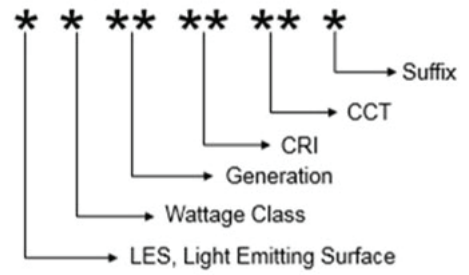

**Dimensional Drawing** <sup>8)</sup>

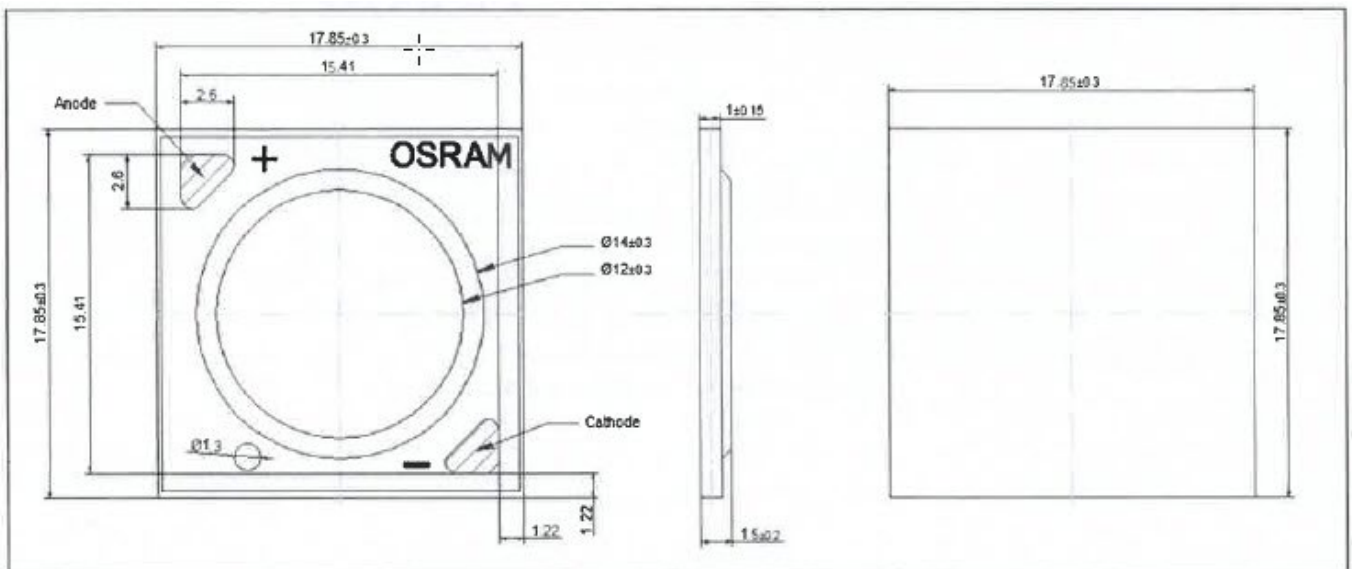

Special Agreement

**Further Information:**

**Approximate Weight:** 863.1 mg

**Tray** <sup>8)</sup>

25 pieces per tray

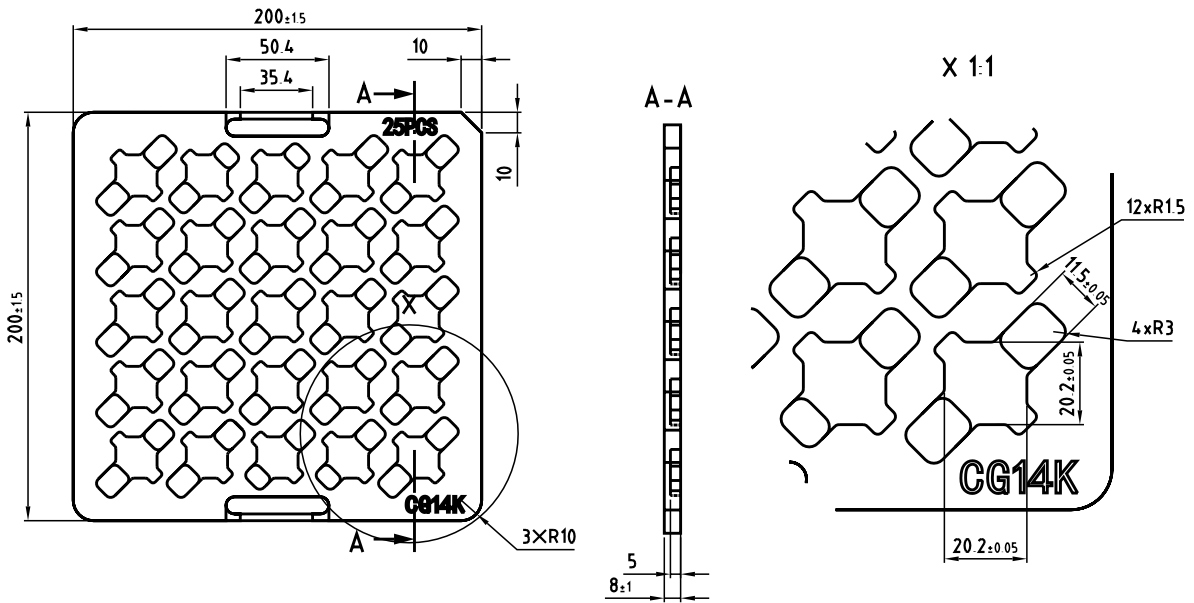

C67062-A0362-X1-01

**Barcode-Product-Label (BPL)**

**OSRAM Opto Semiconductors** LX XXXX BIN1: XX-XX-X-XXX-X

RoHS Compliant

(6P) BATCH NO: 1234567890 ML Temp ST  
X XXX °C X

(1T) LOT NO: 1234567890 (9D) D/C: 1234

(X) PROD NO: 123456789 (Q) QTY: 9999 (G) GROUP: XX-XX-X-X

Pack: RXX  
DEMY XXX  
X\_X123\_1234.1234 X

OHA04563

Special Agreement

---

## Schematic Transportation Box <sup>8)</sup>

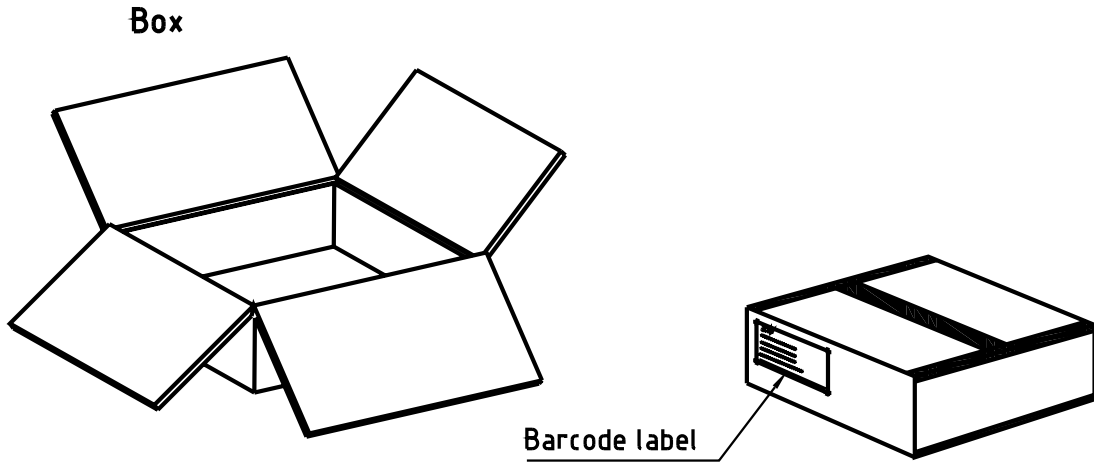

**C67062-A0325-X4-01**

## Dimensions of Transportation Box

Width	Length	Height
225 ± 5 mm	225 ± 5 mm	65 ± 5 mm

---

## Notes

The evaluation of eye safety occurs according to the standard IEC 62471:2006 (photo biological safety of lamps and lamp systems). Within the risk grouping system of this IEC standard, the device specified in this data sheet fall into the class **moderate risk (exposure time 0.25 s)**. Under real circumstances (for exposure time, conditions of the eye pupils, observation distance), it is assumed that no endangerment to the eye exists from these devices. As a matter of principle, however, it should be mentioned that intense light sources have a high secondary exposure potential due to their blinding effect. When looking at bright light sources (e.g. headlights), temporary reduction in visual acuity and afterimages can occur, leading to irritation, annoyance, visual impairment, and even accidents, depending on the situation.

Subcomponents of this device contain, in addition to other substances, metal filled materials including silver. Metal filled materials can be affected by environments that contain traces of aggressive substances. Therefore, we recommend that customers minimize device exposure to aggressive substances during storage, production, and use. Devices that showed visible discoloration when tested using the described tests above did show no performance deviations within failure limits during the stated test duration. Respective failure limits are described in the IEC60810.

This device is designed for specific/recommended applications only. Please consult OSRAM Opto Semiconductors Sales Staff in advance for detailed information on other non-recommended applications (e.g. automotive).

Change management for this component is aligned with the requirements of the lighting market.

For further application related information please visit [www.osram-os.com/appnotes](http://www.osram-os.com/appnotes)

## Disclaimer

### Attention please!

The information describes the type of component and shall not be considered as assured characteristics. Terms of delivery and rights to change design reserved. Due to technical requirements components may contain dangerous substances.

For information on the types in question please contact our Sales Organization.

If printed or downloaded, please find the latest version on the OSRAM OS website.

### Packing

Please use the recycling operators known to you. We can also help you – get in touch with your nearest sales office. By agreement we will take packing material back, if it is sorted. You must bear the costs of transport. For packing material that is returned to us unsorted or which we are not obliged to accept, we shall have to invoice you for any costs incurred.

### Product and functional safety devices/applications or medical devices/applications

OSRAM OS components are not developed, constructed or tested for the application as safety relevant component or for the application in medical devices.

OSRAM OS products are not qualified at module and system level for such application.

In case buyer – or customer supplied by buyer – considers using OSRAM OS components in product safety devices/applications or medical devices/applications, buyer and/or customer has to inform the local sales partner of OSRAM OS immediately and OSRAM OS and buyer and /or customer will analyze and coordinate the customer-specific request between OSRAM OS and buyer and/or customer.



## Glossary

- 1) **Brightness:** Brightness values are measured during a current pulse of typically 10 ms, with a tolerance of +/- 7%.
- 2) **Reverse Operation:** Not designed for reverse operation. Continuous reverse operation can cause migration and damage of the device.
- 3) **Forward Voltage:** The Forward voltage is measured during a current pulse duration of typically 1 ms with a tolerance of  $\pm 0.05V$  .
- 4) **Color reproduction index:** Color reproduction index values (CRI-RA) are measured during a current pulse of typically 10 ms and with a tolerance of  $\pm 2$ .
- 5) **Chromaticity coordinate groups:** Chromaticity coordinate groups are measured during a current pulse duration of typically 10ms with a tolerance of  $\pm 0.005$ .
- 6) **Typical Values:** Due to the special conditions of the manufacturing processes of semiconductor devices, the typical data or calculated correlations of technical parameters can only reflect statistical figures. These do not necessarily correspond to the actual parameters of each single product, which could differ from the typical data and calculated correlations or the typical characteristic line. If requested, e.g. because of technical improvements, these typ. data will be changed without any further notice.
- 7) **Characteristic curve:** In the range where the line of the graph is broken, you must expect higher differences between single devices within one packing unit.
- 8) **Tolerance of Measure:** Unless otherwise noted in drawing, tolerances are specified with  $\pm 0.1$  and dimensions are specified in mm.

---

## Revision History

Version	Date	Change
1.0	2020-08-07	Initial Version
1.1	2021-09-10	Maximum Ratings Electro - Optical Characteristics (Diagrams) Derating (Diagrams)

---

**Published by OSRAM Opto Semiconductors GmbH** EU RoHS and China RoHS compliant product  
**Leibnizstraße 4, D-93055 Regensburg**  
**www.osram-os.com © All Rights Reserved.**



此产品符合欧盟 RoHS 指令的要求；  
按照中国的相关法规和标准，不含有毒有害物质或元素。